



*The #1 Choice in
Performance Boating!™*

DEPTH SONAR
Model #GL600 All Colors
Installation Instructions

HOW SONAR WORKS. Sonar uses sound waves to determine the presence and location of underwater objects. The time measured between the transmission of the sound wave, and the reception of any reflection can be used to determine distance. Analysis of the reflected signal can also be used to determine location, size, composition, etc.

The depth sounder consists of two primary components: the sonar unit and the transducer. The sonar unit contains the transmitter and receiver, as well as the user controls and display. The transducer is mounted beneath the water surface and converts electrical energy from the transmitter into mechanical pulses or sound waves. The transducer also receives the reflected sound waves and converts them back into electrical signals for display on the sonar unit.

The transmit and receive cycle is very fast. A sound wave can travel from the surface to a depth of 240' and back again in less than 1/4 of a second; so it is unlikely that your boat can "outrun" this sonar signal. As the transducer receives sonar signals, it converts them to a digital depth that is displayed on your depth sounder. The depth reading is continuously updated as you travel across the water.

Easy-to-use controls on the depth sounder allow you to set the shallow alarm or deep alarm for an audible alert when the boat is in extreme shallow or deep water. The liquid crystal display (LCD) offers sharp viewing, even in bright direct sunlight and is continuously lit for nighttime operation.

Note: Actual depth capability depends on such factors as bottom hardness, water conditions, and transducer installation. Units will typically read to deeper depths in fresh water than in salt water.

USING THE GL600(W). The GL600(W) depth sounder uses a backlit 7-segment display in conjunction with a 3-button keypad to control all user functions. At initial power-up, the unit will begin normal operation and display the digital depth and the units of measure.



Figure 1 shows a typical view you might see on-screen at initial power-up.

CONTROL FUNCTIONS. The depth sounder uses 3 buttons to control the shallow alarm, deep alarm, keel offset, and units of measure function. While in normal operation, pressing the set button selects a function and blinks its corresponding indicator on the display. Once a function has been selected it may be adjusted by pressing the up and down arrow buttons to adjust the setting further presses of the set button will sequentially select the other functions for adjustment. All user settings are remembered by the depth sounder, even when powered off.

When in an active function, a single press to an arrow button will result in a single incremental adjustment. Pressing and holding an arrow button will sequence through a range of adjustments. If no adjustment is made for 5 seconds, the unit will return to normal operation.

SHALLOW ALARM. The shallow alarm function can be set for depths ranging from 1 to 20 feet and sounds an alarm when the depth is less than the setting.

From normal operation, pressing set once will display the shallow alarm setting and blink the "shallow" icon. The up arrow will activate the shallow alarm and also increase the selected value. The down arrow will reduce the value. Hold the up arrow until you reach the desired depth setting.

Note: The maximum shallow alarm setting cannot meet or exceed the current deep alarm setting.

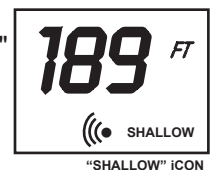

After your selection is made, the unit will return to normal operation after 5 seconds. The "shallow" icon should now be visible (Figure 4).

If the depth of the water is less than the selected value, the alarm will sound and the "shallow" icon will blink to indicate the alarm. Pressing any button will mute the alarm and activate the shallow alarm function for additional adjustment. To permanently turn the alarm off, use the down arrow to return the display to "off."

DEEP ALARM. The deep alarm can be set for depths up to 99 feet and sounds an alarm when the depth is greater than the setting.

Press set until the deep alarm function becomes active. This is indicated by the blinking "deep" icon. The up arrow will activate the deep alarm and also increase the selected value. The down arrow will reduce the value. Continue to press and hold the up arrow until you reach your desired value.

Note: The minimum deep alarm setting cannot meet or go below the current shallow alarm setting.

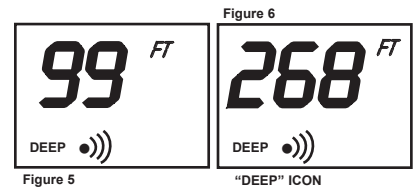

After your selection is made, the unit will return to normal operation after 5 seconds. The "deep" icon should now be visible as shown in figure 6.

If the depth of the water is greater than the selected value, the alarm will sound and the icon will blink to indicate the alarm. Pressing any button will mute the alarm; pressing set will mute the alarm and activate the deep alarm function for additional adjustment. To permanently turn the alarm off, use the down arrow to return the display to "off."

UNITS. The units control function selects the units of measure for depth readout and alarm functions.

The three settings available are feet, meters or fathoms. Press set until the units function is activated on the screen. This is indicated by the blinking units icon. Pressing either arrow will allow you to select from the choices. Continue to press an arrow until the desired readout is selected: "FT" for feet, "M" for meters, "FA" for fathoms.



Figure 7

After your selection is made, the unit will return to normal operation after 5 seconds. The selected units icon should now be visible as shown in figure 8.

KEEL OFFSET. The keel offset function adjusts the digital depth readout to display depth readings from either the waterline or the keel (lowest point) of the boat, instead of from the location of the transducer which is usually somewhere in between. This permits optimum transducer location and depth readouts suited to your needs.

To determine the value to enter into the keel offset setting, first decide whether depth from the waterline or depth from the keel if desired. Measurements will need to be made for the location desired.

For depth from the keel of the boat, accurately measure the vertical distance between the face of the transducer and keel of the boat. This measurement will then be entered into the keel offset function as a negative (-) number. (Figure 9)

For depth measurements from the waterline, accurately measure the vertical distance between the face of the transducer and the waterline of the boat. This measurement will then be entered into the keel offset function as a positive (+) number. (Figure 10).

To enable keel offset press "set" until the "KO" icon is displayed on the screen. The default icon is displayed on the screen. The default setting of the unit is off which is displayed as zero. From the default setting of 0.0 use the down arrow to enter the negative (-) number to set the unit for depth from the keel. Or, from the default setting 0.0, use the up arrow to enter a positive (+) number to set the unit for depth from the waterline.

The available settings are +10 to -10 feet. After your selection is made, the unit will return to normal operation after 5 seconds. The "KO" icon should now be visible as shown in figure 13. Figures 11, 12, and 13 depict a scenario where the keel offset has been set to -2 feet. Figure 13 shows the return to normal operation with the updated depth readout.

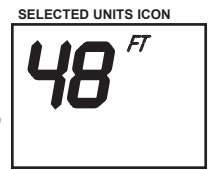

Figure 8

Negative Keel Offset



Figure 9



Figure 10



Figure 11



Figure 12



TRANSDUCER INSTALLATION

For best results, read all the mounting instructions before you begin the installation, and please follow the instructions carefully. Improper installation of the transducer can affect the efficiency and accuracy of the entire system. You need either an epoxy kit or silicone sealant, depending on the mounting option. Next, choose the mounting option to use; Transom Mount or Inside Hull Mount, as described below.

The **Inside Hull Mount** option places the transducer inside the hull, and requires the use of a proper 2-part epoxy such as LMI's Epoxy Kit. Though there is some signal loss in shooting through the hull, your GL600 will perform well with this mounting, but do not use it in an aluminum boat.

TRANSOM MOUNT INSTALLATION

NOTE: The transducer must be mounted where water flow will be in constant contact. The transducer will not work when transmitting through air or air bubbles. You may want to observe the rear of the boat as it moves through the water to determine the best mounting location.

1. When mounted, the bottom of the transducer should be at least 1/8" below the bottom of the transom; the top of the transducer must remain above the bottom of the transom. **NOTE:** If your boat has a stepped transom below the main transom, you should mount the transducer on the stepped transom. This ensures good readings at very high speeds.
2. Mark and drill the holes as shown. Apply a silicone sealant between the screw heads and the brackets (to keep water from leaking into the hull), and attach the metal bracket with the screws provided. Be sure the screws are centered in the slots and loosely tighten screws.
3. Attach the pivot to the transducer by using the 5/8" long, 1/4" allen-head screws, toothed washers, and square nuts. Do not completely tighten the allen screws yet.
4. Insert transducer/pivot assembly into the metal bracket on the transom from the bottom up, sliding the assembly up until the holes in the pivot line up with the holes in the bracket. Use the headed pin, O-ring, and 3/8" long allen-head screw to secure the transducer in the bracket.
5. Adjust the transducer's running angle so that it is parallel with the bottom of the boat hull. Then tighten down the allen-head screws that hold the transducer to the pivot tightly.
6. Adjust the height of the transducer so that the face is 1/8" to 1/4" below the hull and tighten the 3 wood screws. Lock washers must be installed between the pivot and the transducer ears.
7. Install the cable clamps by drilling 1/8" holes and using the clamps and screws provided. Be sure to run the cable to the side of the transducer and leave slack, not in the center, to prevent damage to the cable should the transducer kick-up. **NOTE:** The transducer transom-mount installation is now complete.

Skip to "Installing the GL600."

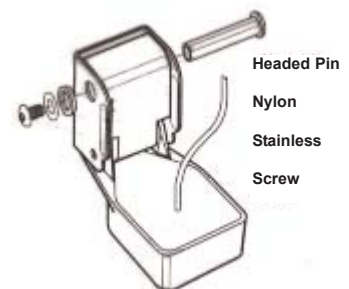
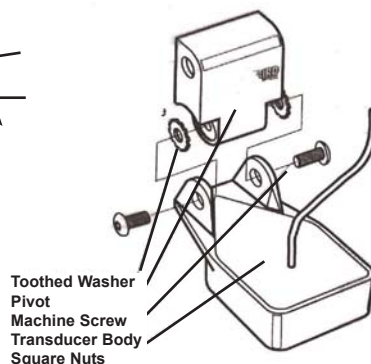
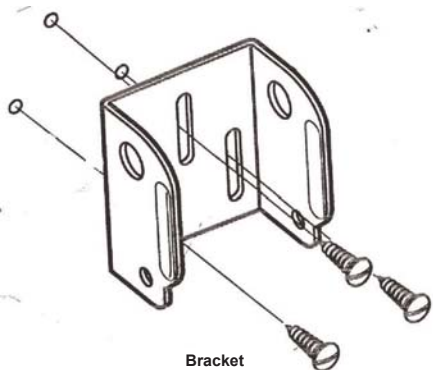
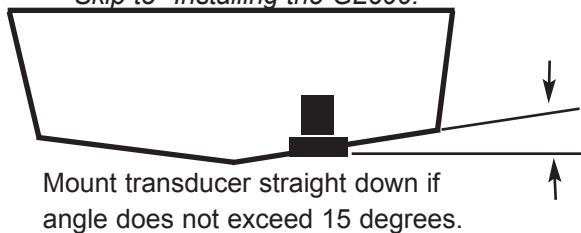

INSIDE HULL INSTALLATION

Follow the steps below if you are mounting the transducer inside the hull, rather than on the transom. As described in these steps, this installation requires that you first install the GL600, then "test-position" the transducer and try out the positioning before making the permanent installation. NOTE: Though in-hull mounting generally produces good results. LMI cannot guarantee maximum depth performance when the transducer is mounted inside the hull. Since the transducer will be transmitting and receiving through the hull, there will be some loss of signal strength. The amount of loss is determined by hull construction and thickness, the amount of air in the hull, and the transducer installation. Note also that inside-hull installation required a 2-part epoxy kit. The LMI Epoxy Kit is specially formulated for inside hull transducer installations; see you local dealer or call our factory for assistance. Do not use silicone sealant or any soft adhesive to bond the transducer to the hull. as this will reduce the sensitivity of the unit.

This is a permanent installation. Once the transducer is installed, it is not possible to remove it without damaging the transducer or the boat. Be sure to follow the steps on the next page to find a suitable location before installing.

1. Skip to "Installing the GL600" to install the depth finder. When finished, return here.
2. To find the best area for mounting, it is possible to "test position" the transducer in a pool of water to experiment with different locations before making a permanent installation. Select the flattest area near the center of the aft end of the boat where the hull is thin and overly thick. If there is a runner down the center of the boat, select an area to one side of it, but as close to the runner as possible.
3. Put approximately one inch of water in the mounting area. Place your transducer in the water or in a ziplock bag full of water. The bottom of the transducer should be in a flat area and should be in good contact with the bottom of the boat.
4. Operate the GL600 with the boat running at high speed. You may have to move the transducer a bit to find an area that gives satisfactory performance.
5. When you find an area that gives good results, mark the location for mounting. Remove the water and the transducer. Clean the bottom of the transducer thoroughly with liquid detergent. Clean the marked area where the transducer is to be mounted with lacquer thinner. Also clean the outside of the boat in this area, but not with lacquered thinner.
6. Using the LMI Epoxy Kit (or equivalent), mix an ample amount of epoxy without causing it to bubble, and pour it in the area where the transducer is to be mounted. The puddle should be larger than the bottom of the transducer. Using a paper cup cut in half will help dam up the epoxy.
7. Coat the bottom of the transducer with epoxy, then put it in the center of the puddle and push down on the transducer while moving it around in a circular motion. This forces out any air bubbles that may be trapped between the bottom of the transducer and the hull of the boat.
8. Transducer must be secured in place while epoxy is curing. Either tape the transducer to the hull, or place a weight on it until the epoxy cures. When the epoxy has cured, the transducer is ready to operate. (No water is required in the bottom of the boat, and gas or oil spilled inside the boat will not degrade performance.)

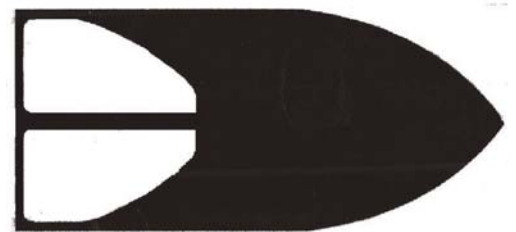

Air is sometimes trapped in the lamination of glass fiber hulls. Since sonar signals cannot be transmitted through air, it is imperative to find an area of the hull which is free of trapped air. Also, this area should be in contact with a smooth non-turbulent flow of water at high speeds. Recommended area for inside hull mounting

Thru-Hull mounted transducers will not shoot through coring or aluminum bottoms. Coring must be removed in these applications.

TRANSDUCER TROUBLESHOOTING TIPS

1. Once connected to the battery, or once the switch to which the unit is wired is turned on, nothing happens, check your power cable connection and fuse. Be sure the power cable is properly connected to the battery - red lead to the positive (+), black lead to the negative (-) terminal.
2. There's no bottom reading on the display. Check the transducer cable connection on the back of the unit. Make sure the transducer is not sitting above the water.
3. When in very shallow water, the unit does not display a continuous depth.. This is normal in water depths of one foot or less, because the automatic range control can't lock onto the bottom in water that shallow.
4. The bottom reading disappears during hard turns. This is normal, as the transducer comes out of the water in a hard turn, and will correct itself.
5. The screen begins to fade out. Digits on the screen are not as sharp and clear as normal. Check the battery to see that it is fully charged; the GL600 will not operate properly on less than 11 volts.

GL600 INSTALLATION.

The mounting surface should be adequately supported to protect the GL600 from excess wave shock and vibration. The mounting area should allow at least 2" clearance at the back, sides, and top of the unit for connection, air flow, and ease of removal. Any VHF radio you have may incur some degree of interference with the depth finder. LMI depth finders are designed to minimize interference although it is best to route the transducer cable and antenna cable as far away from each other as possible - for example, on opposite sides of the boat. After you have determined the best location for your GL600, proceed with the following instructions.

1. Locate an area on the dash or panel which is visible to the boat operator and free from obstructions such as the throttle, steering mechanism or other gauges. The panel should be sufficiently sturdy to protect the GL600 from excessive shock. The maximum recommended panel thickness is 3/4", although thicker panels may be accommodated by modifying the "U" bracket.
2. Mark the desired location and drill a pilot hole. Drill a 2 1/8" diameter hole using a hole saw and hand drill. Since this is a standard hole size, hole saws are readily available for rental or purchase, or any marine service shop can handle this task. Insert the GL600 from the front of the panel.
3. From the rear of the panel, install the "U" bracket and wingnut as illustrated, ensuring the fact that the GL600 is rotated upright. If the panel into which you are mounting the unit is greater than 1/4" thick, the "U" bracket may appear to be long. If this is the case, use pliers to break the legs of the "U" bracket at the score lines to reduce its length. It is a good idea to shorten the bracket gradually (one tab at a time). Tighten the wingnut.
4. The alarm buzzer can be mounted to the gimble bracket using the machine screw and nut. Holes are provided in the bracket for this purpose, or you may mount the buzzer directly to the boat dash or surrounding wiring using the self tapping screw or the cable tie. The alarm buzzer can also be panel mounted.
5. The power cable can be wired to any 12 volt DC power source, but wiring directly to the boat's fuse panel is most desirable. Connect the black lead to the negative terminal and the red lead to 12 volt DC positive. Use a 1 amp fuse in the fuse panel or if wiring directly to the battery, use an in-line fuse holder with a 1 amp fuse. Do not connect the red lead to the power source without a fuse.

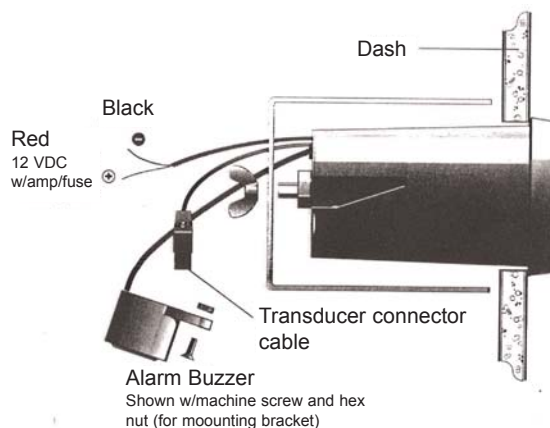

TESTING AND USING. After installing your GL600, transducer, and cables you should test the installation. Testing should be performed on the water, since that is the only way to check your transducer's performance. When the boat ignition is turned on, the GL600 will perform a self test and then begin transmitting, and automatically display the digital depth. (If the GL600 is wired to a switch, turn that switch on.)

Increase your boat's speed to ensure that you get a continuous bottom reading as the boat moves. Your GL600 and its transducer are designed to operate at up to 75 mph, so feel free to test them at high speeds.

If the GL600 performs well at idle or slow speeds, but the display is not continuous at higher speeds, the transducer is not installed properly. Air bubbles or turbulence from the boat hull are passing across the transducer face, blocking the transmitted signal. By following the instructions in "Mounting the Transducer", you can make simple adjustments that should fix the problem.

GL600 TROUBLESHOOTING TIPS. Do not attempt to repair the depth sounder yourself. There are no user serviceable parts inside, and special tools and techniques are required for reassembly to ensure the waterproof integrity of the housing. Repairs should be performed only by authorized technicians.

Many requests for repair received involve units that do not actually need repair. These units are returned "no problem found." If you have a problem with your depth sounder, consult the following Troubleshooting Guide before calling customer support or sending your unit in for repair.

1. Nothing happens when I turn the unit on. Check the power cable connection at both ends. Be sure that the cable is connected correctly to a reliable power source--red lead to positive, black lead to negative or ground. Ensure that the power available at the mount is between 10 and 16 VDC. If the unit is wired through a fuse panel, ensure that the panel is powered. Often accessory fuse panels are controlled by a separate switch or the ignition switch. Also, often a fuse can appear to be good when in fact is not. Check the fuse with a tester or replace it with a fuse known to be good.
2. There is no bottom reading visible on the display. There are a number of possible causes for this condition. If the loss of bottom information occurs only at high boat speeds, then a transducer adjustment is needed. (Refer to transducer installation). Check the transducer cable connection on the back of the unit and ensure that the cable has not been cut or pinched. Even a small abrasion in the cable can significantly affect performance.
3. When in very shallow water, the unit does not display a continuous depth. This is normal in extremely shallow water, because the automatic range control cannot lock onto the bottom in depths of one foot or less.
4. The screen begins to fade out. Images are not as sharp as normal. Check the input voltage. The depth sounder will not operate on input voltages below 10 VDC.
5. The bottom reading disappears during a hard turn. This is normal, as the transducer comes out of the water in a hard turn and will correct itself.

MAINTENANCE. The GL600 depth sounder is designed to provide you with years of trouble-free operation with virtual no maintenance. Follow the simple procedures below to ensure that our depth sounder continues to deliver top performance. If the unit comes into contact with salt spray, simply wipe the affected surfaces with a cloth dampened in fresh water. Do not use a chemical glass cleaner on the lens. Chemicals in the solution may cause cracking in the lens of the unit.

When cleaning the LCD protective lens, use a chamois and non-abrasive, mild cleaner. Do not wipe while dirt or grease is on the lens. Be careful to avoid scratching the lens. If your boat remains in the water for long periods of time, algae and other marine growth can reduce the effectiveness of the transducer. Periodically clean the face of the transducer with liquid detergent. Pivoting the transducer up in the bracket may allow better access for inspection or cleaning.

If your boat remains out of the water for a long period of time, it may take some time to wet the transducer when returned to the water. Small air bubbles can cling to the surface of the transducer and interfere with proper operation. These bubbles will dissipate with time, or you may wipe the face of the transducer with your fingers after the transducer is in the water. Never leave your depth sounder in a closed car or trunk. The extremely high temperatures generated in hot weather can damage the electronics.