



Livorsi Platinum Series Control Installation and Operation Manual

Standard, Billet and Arched Handles

Revised JUNE 2017

Table of Contents

Introduction	3
Tools needed.....	3
Installation	3
Using Mounting Templates / Patterns.....	3
Adjusting Detent and Friction.....	3
Fully Electric Control.....	4-5
Hybrid (Electric / Mechanical).....	6
Mounting Templates	7-10
Maintenance	11
Corrosion Protection.....	11
Warranty	11

INTRODUCTION

Thank you for choosing Livorsi Marine® controls. Your new marine engine controls feature a one year warranty and are built using aluminum and stainless steel to insure years of trouble free service.

Tools Needed:

To install your controls the following tools are needed:

* Phillips screwdriver * 7/16" wrench or socket * 3/16" Allen wrench

NOTICE

The included 4 O-rings, and 4 stainless steel wood screws **MUST** be used to install the control or it will void the warranty. Do not over tighten. Its best to use grease in screw holes to prevent breaking chrome finish.

INSTALLATION

Using Mounting Templates

Utilize the template provided on page 5 for appropriate control cut out pattern. When printing the template, make sure your print settings do not resize the document. Print templates at 100% scale

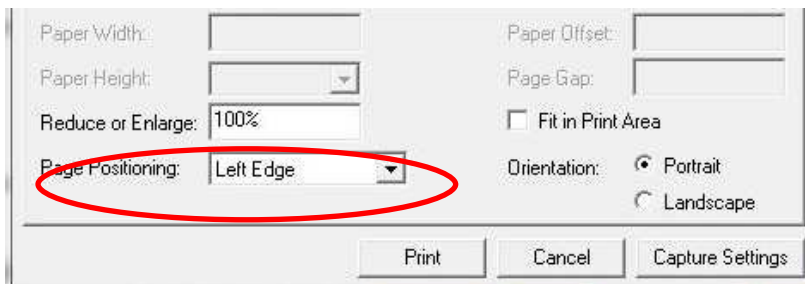

Adjusting Detent and Friction:

Adjust detent and friction to desired tension by turning allen screw at base of handle.

Place throttle arm and/or detent in the slightly forward position. Using a 3/16" allen wrench, reach through the black rubber to the 3/16" set screw. Tighten or loosen as needed.

Periodic lubrication of rubber boots in needed. Teflon base lubricant works best.

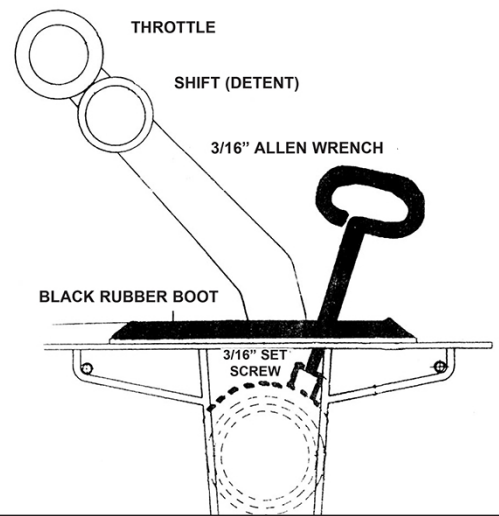

INSTALLATION - CONT.

Full Electric Control

Single Switch function associated with highlighted harness.
Red = +12 vdc
Green = Down
Blue = Up



Deutsch plug connects to the engine's controller

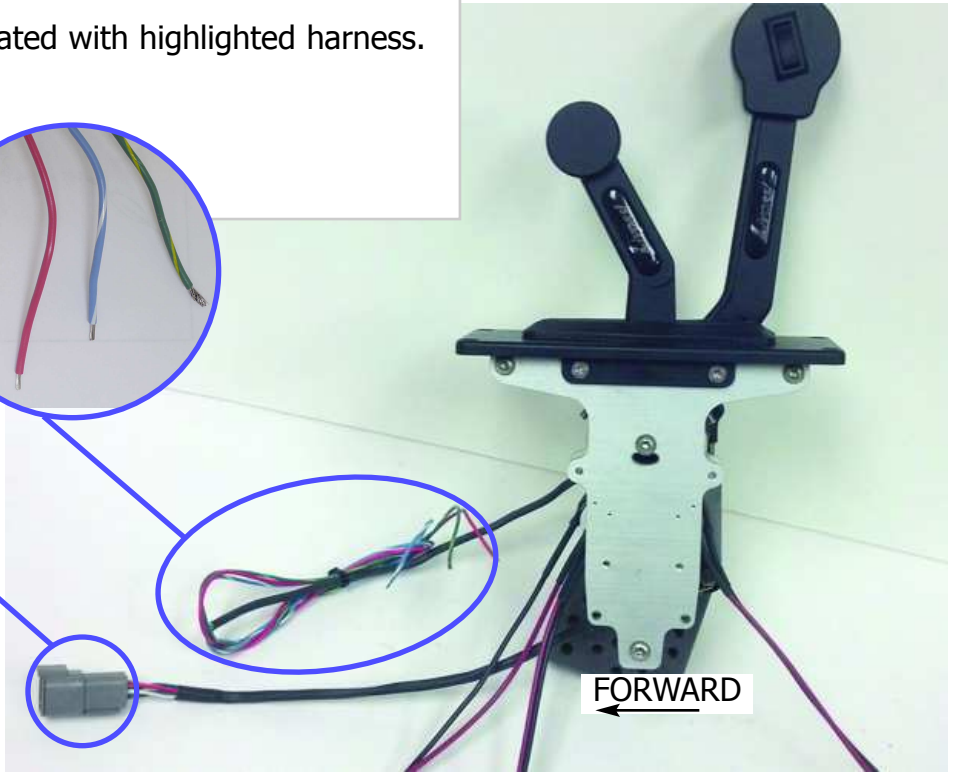

Throttle controlled by 0-5 volt potentiometer programmable to customer's specifications. Control will be labeled for forward direction, DO NOT reverse.

Shift lever in reverse position will close highlighted circuit.



INSTALLATION - CONT.

Full Electric Control

Shift lever in Neutral position will close highlighted circuit.

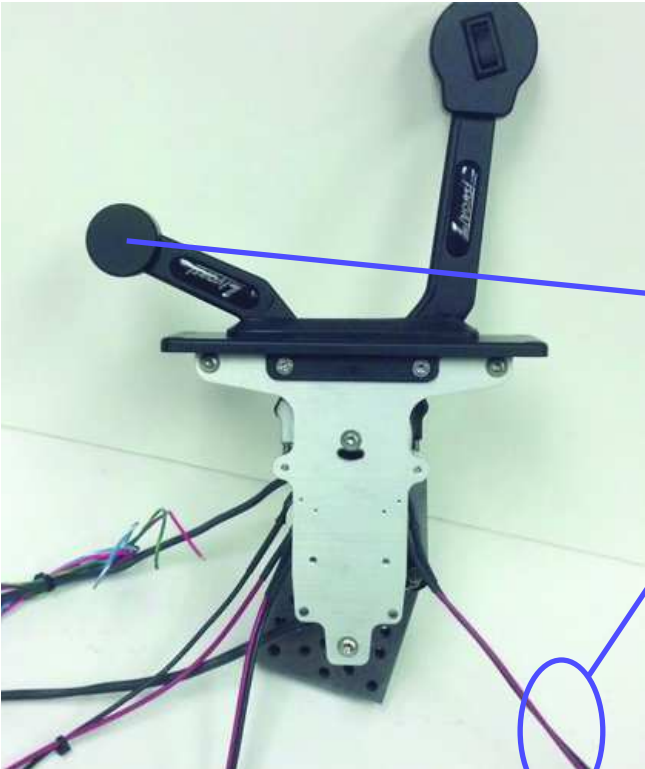

Shift lever in Forward position will close highlighted circuit.

INSTALLATION - CONT.

Hybrid (Electric/ Mechanical)

For Livorsi Hybrid Platinum Series controls where either the throttle is electronic and shift is mechanical or vice versa, the use of 33C series cables are needed.

1. When installing new controls it is suggested to use new cables. When removing old cables, attach new cables and route as you remove old cables.
2. After connecting cables to engine and transmission, connect cables to controls using hardware provided. Screw end clevis on cable. Remove plate or brad on side of lever to expose installation point.

Note:

Two mounting points are provided to adjust different cable throws.

3. Install pin in clevis and insert into desired mounting hole. Reinstall brad to hold pin.
4. Use "U" bracket to secure cable to base of control.
5. Repeat on additional handles before installing control in desired installation location.
6. Control is now ready to be installed in the desired location.
7. Use the included O-rings and stainless steel wood screws to secure the control to surface. These O-rings and stainless steel wood screws **MUST** be used to install the control or it will **void the warranty** on the control. Do not over tighten. Use grease on screws for first time installation.

WARNING: Make sure to adjust cables before operating engines.

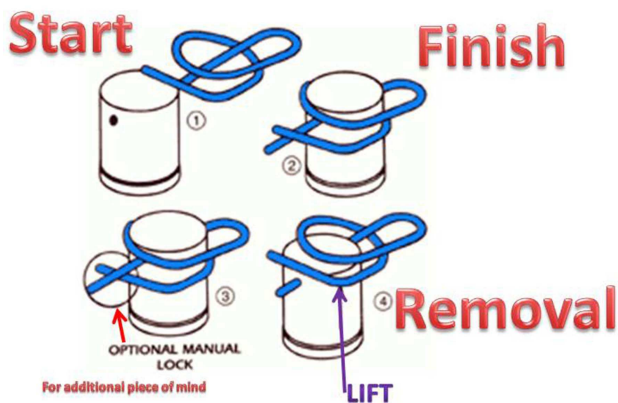

MOUNTING TEMPLATES

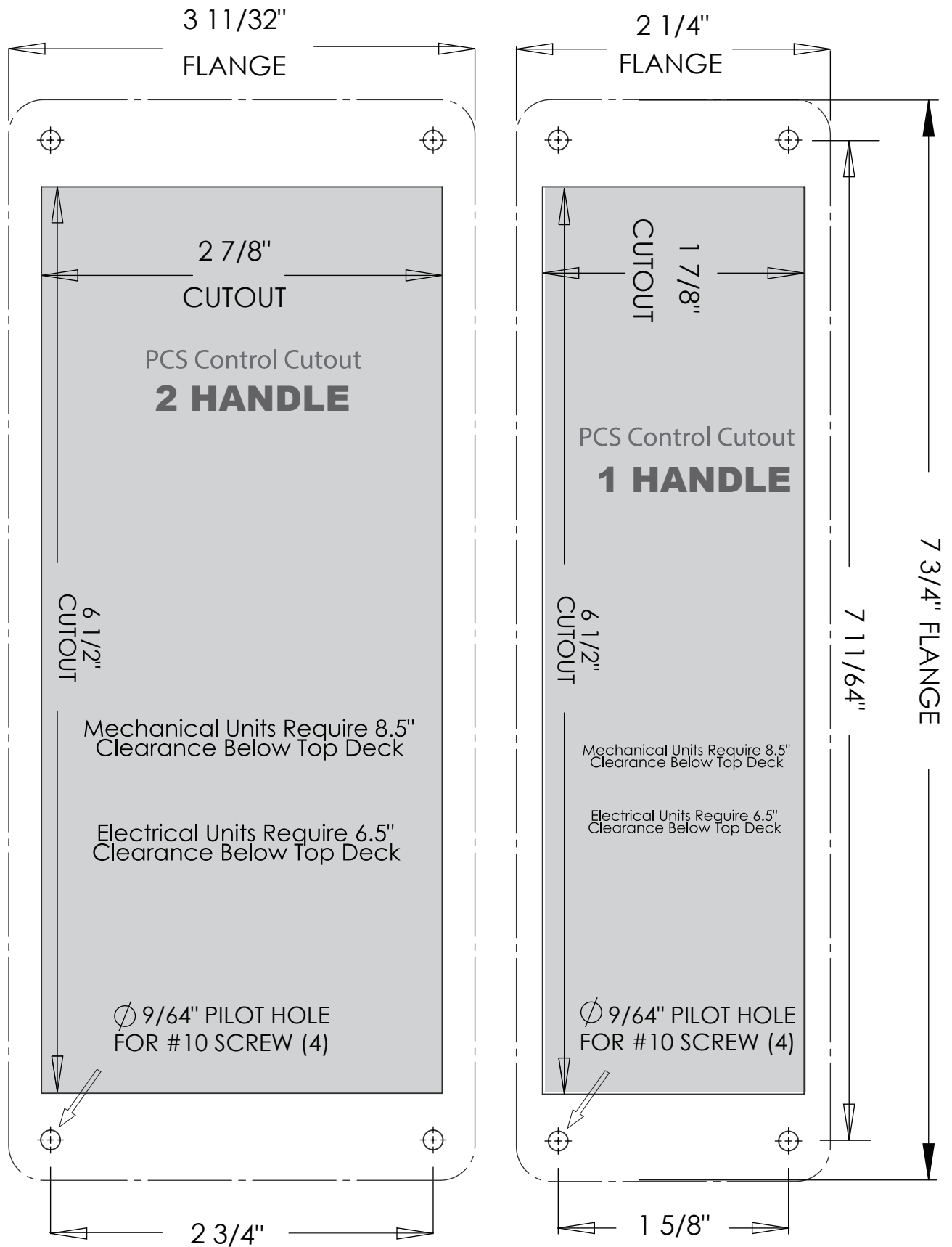

INTENTIONALLY LEFT BLANK

MOUNTING TEMPLATES - CONT.

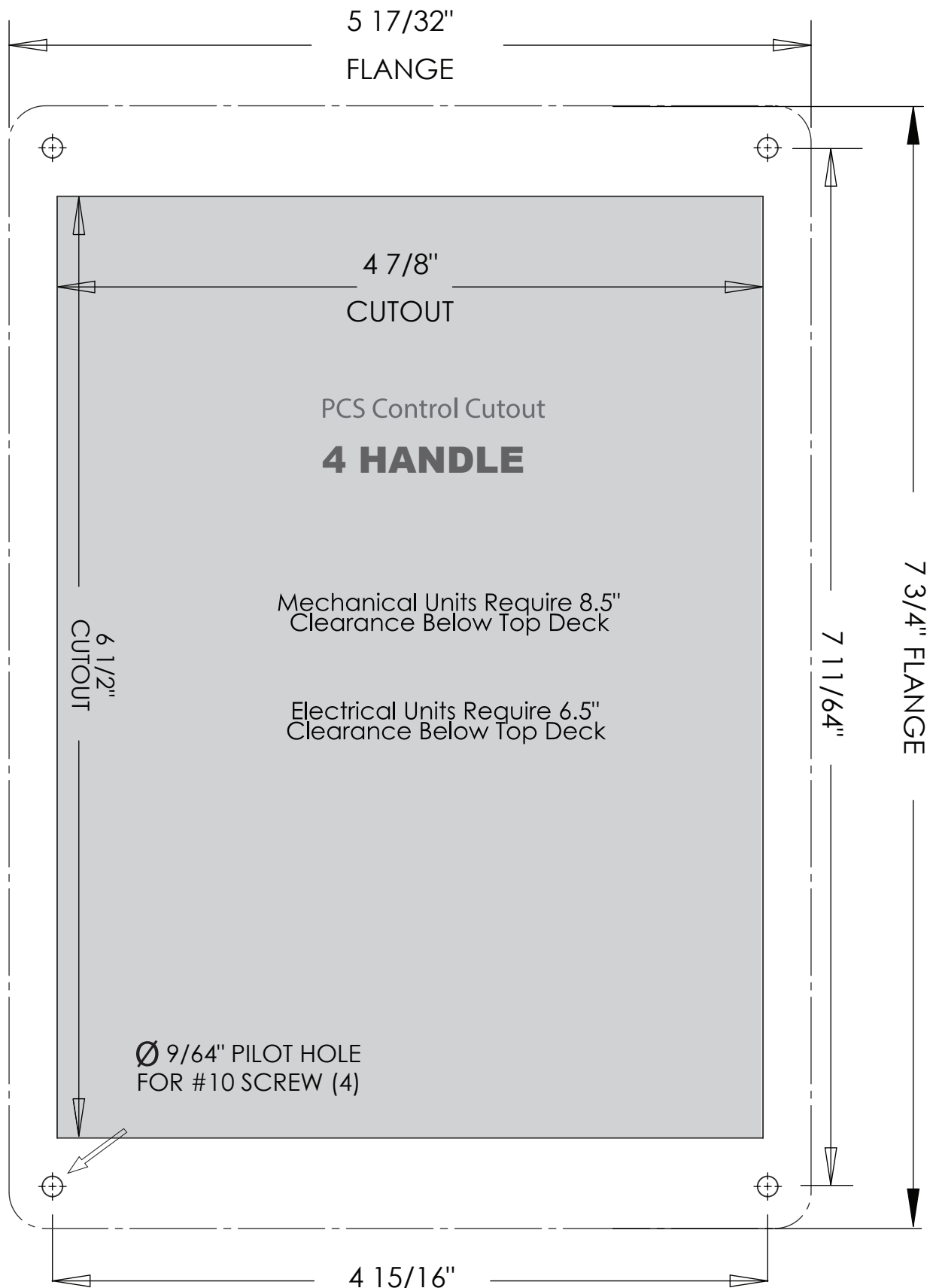

INTENTIONALLY LEFT BLANK

MOUNTING TEMPLATES - CONT.

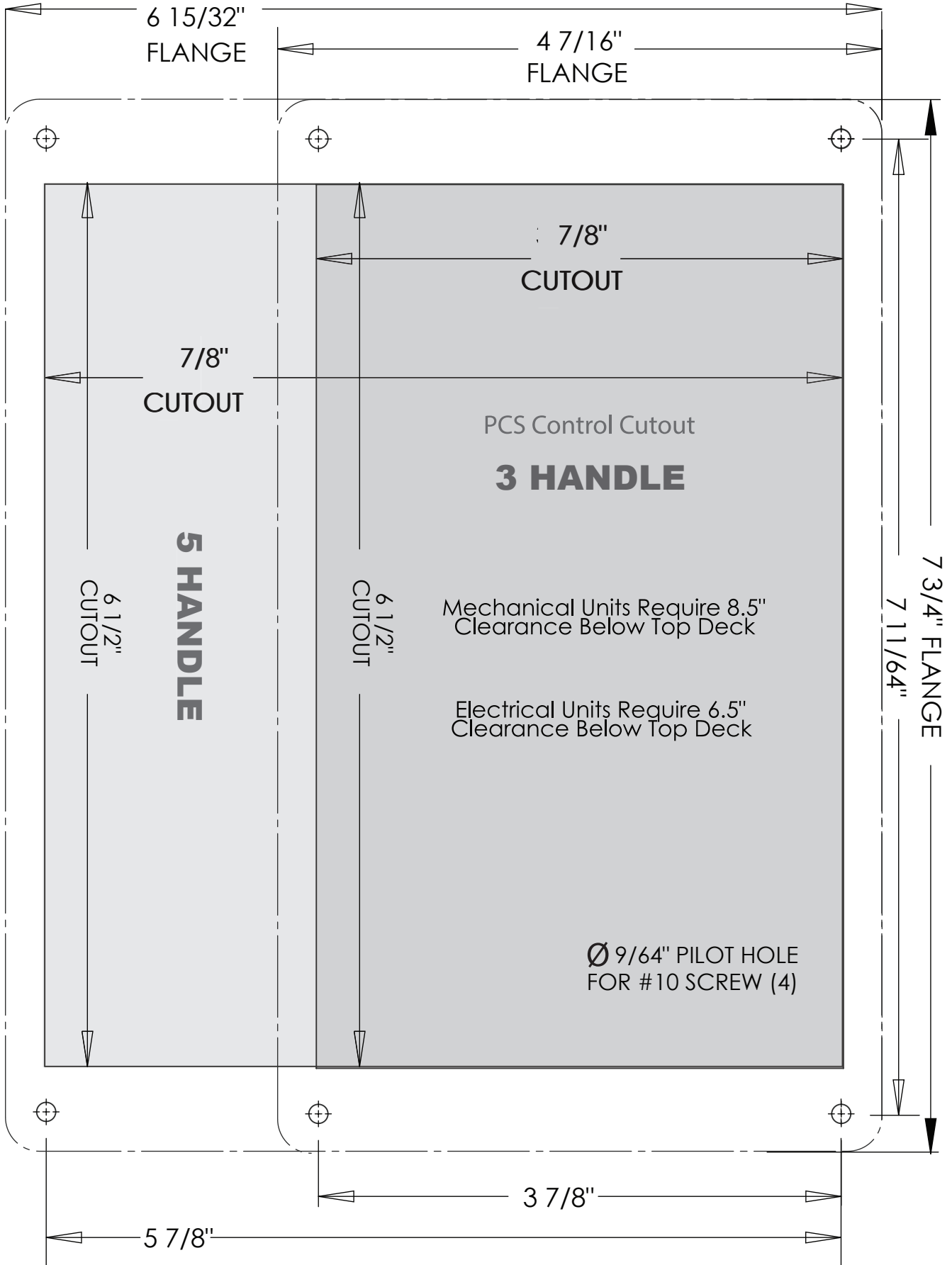

INTENTIONALLY LEFT BLANK

MOUNTING TEMPLATES - CONT.

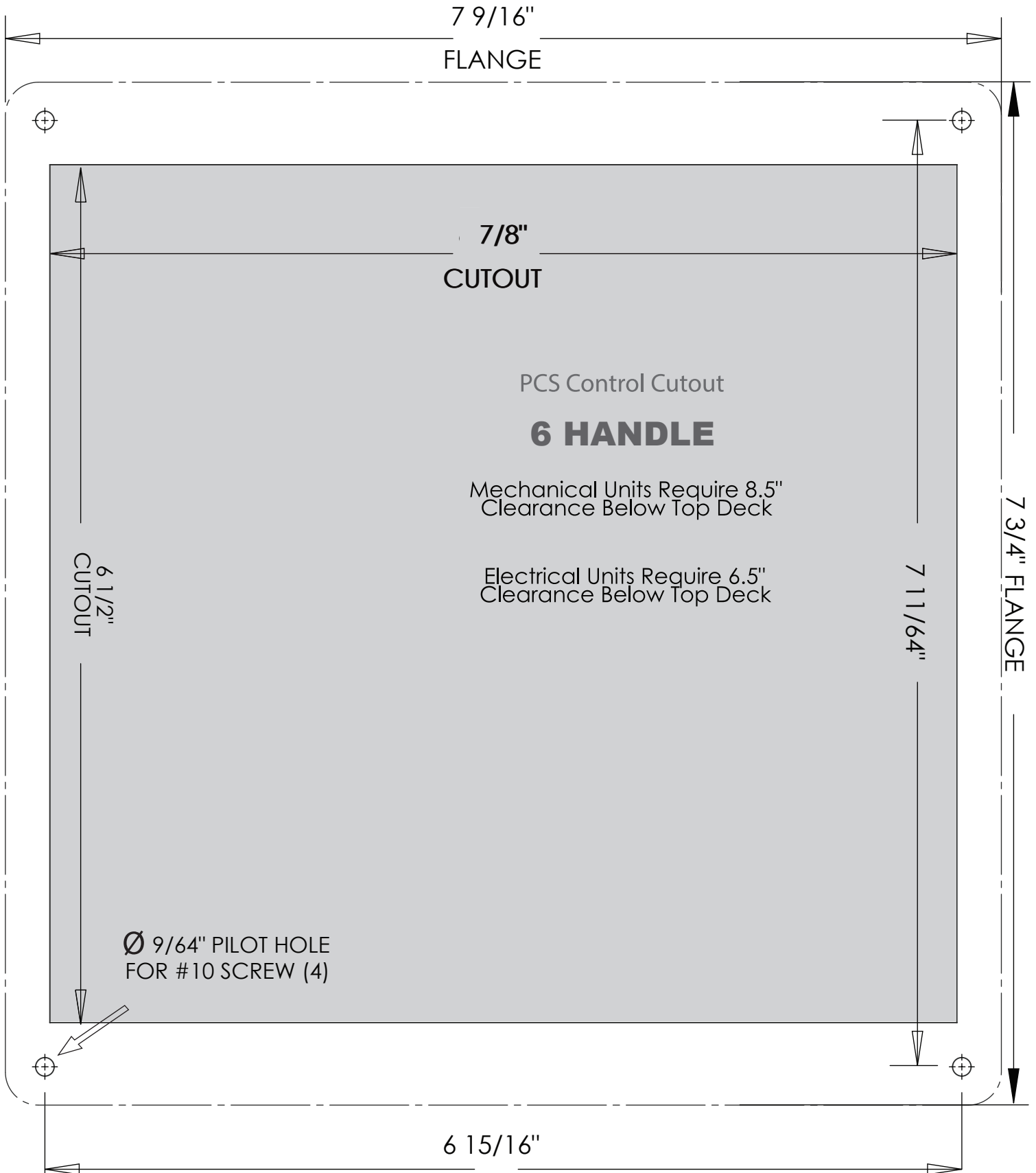

INTENTIONALLY LEFT BLANK

MAINTENANCE

Corrosion Protection:

For maximum protection, especially in a saltwater environment, the control head and hand lever should be washed lightly with fresh water on a regular basis.

- Periodically check the control head mechanism for loose fasteners and signs of wear on moving parts.
- Keep moving parts well lubricated with a moisture-displacing lubricant.
- Periodically check the cables and engine connections for signs of wear and corrosion. Replace as necessary.

WARRANTY

All Livorsi Marine® products carry a limited one year warranty for repair or replacement at Livorsi's discretion. All Livorsi Marine® products are warranted to be free of defects in material and workmanship. Users/Customers of Livorsi Marine®/Livorsi® products agree not to hold Livorsi Marine, Inc., its owner or employees responsible for any damages occurring by improper installation or use of Livorsi Marine® or Livorsi® products. The company, owner or its employees will not be liable for more than the cost of the original product and in no event will Livorsi Marine® or Livorsi® be liable for special, indirect or consequential damages of any kind whatsoever.



715 Center Street
Grayslake IL 60030
P: 847-752-2700 F:
847-752-2415 E:
info@livorsi.com

Copyright © Livorsi Marine Inc.® All Rights Reserved.

One of the **CompX** Companies
MARINE
