

Data Gateway Installation

Automotive/Marine

With the Livorsi Data Gateway you can export CAN (Controller Area Network) engine data to a NMEA 2000® device and display engine data. For use with Vantage View® gauges or a NMEA 2000® navigation device such as Garmin, Lowrance or Raymarine. Please note that engine data is only transmitted if there is a sensor to support it.

Use this gateway to translate information to our state of the art Vantage View® Gauges.

Livorsi's Data Gateway simply plugs into a standard NMEA 2000® Tee connector which can be hooked directly to your device. On the engine side it will interface via CAN+ / CAN- wires to gather the info and send it off to a screen and or gauges.

Model Description	Part Number
MEFI to NMEA2K	LGM4N2K
J1939 to NMEA2K	LGJN2K
MoTeC to NMEA2K	LGMN2K
OBD2 to J1939 (GM only)	LGOBDJ
harness	GATEWH



Data Gateway Installation Parameter List

Automotive/Marine

Your engine application may or may not output all of the parameters listed below. Contact your engine manufacturer for a detailed list.

NMEA 2000 Output Parameters (Tx)				SAE J1939 Output Parameters (Tx)	
Input Parameter(Rx)	MEFI4A	MEFI4B	MEFI5/6 (J1939)	Input Parameter (Rx)	OBDII
Air Temperature	X	X	X	Air Temperature	X
Barometric Pressure	X	X	X	Barometric Pressure	X
Battery Potential	X	X	X	Battery Potential	X
Boost Pressure	X	X	X	Boost Pressure	X
Engine Coolant Temperature	X	X	X	Engine Coolant Temperature	X
Engine Coolant Pressure	X	X	X	Engine Coolant Pressure	
Engine Fuel Rate	X	X	X	Engine Fuel Rate	X
Engine Hourmeter	X	X	X	Engine Hourmeter	
Engine Inlet Air Temp				Engine Inlet Air Temp	X
Engine Percent Load	NA (EEC2) ²	NA (EEC2) ²	X1	Engine Percent Load	X
Engine Oil Pressure	X	X	X	Engine Oil Pressure	X
Engine Oil Temperature	X	X	X	Engine Oil Temperature	X
Engine Speed	X	X	X	Engine Speed	X
Engine Percent Torque	NA (EEC2) ²	NA (EEC2) ²		Engine Percent Torque	
Fuel Level				Fuel Level	X
Fuel Pressure	NA (EFL/P1) ²	NA (EFL/P1) ²	X	Fuel Pressure	X
Run Time Since Start				Run Time Since Start	X
Throttle Position	NA (LFE) ²	NA (LFE) ²	X ³	Throttle Position	X
Vehicle Distance (Since DTC clear)				Vehicle Distance (Since DTC clear)	X
Vessel Speed	X	X	NA (MEFI4B) ²	Vessel Speed	X
Current Gear				Current Gear	X
Engine Discrete Status:					
Check Engine	X	X			
Rev Limit Exceeded	X	X			
Low Oil Pressure	X				
Low System Voltage	X				
Low Oil Level	X				
General Warning 1	X				
General Warning 2	X				
Low Fuel Pressure	X				
Emergency Stop Mode	X				
Engine Over Temp	X				

Data Gateway Installation

Automotive/Marine





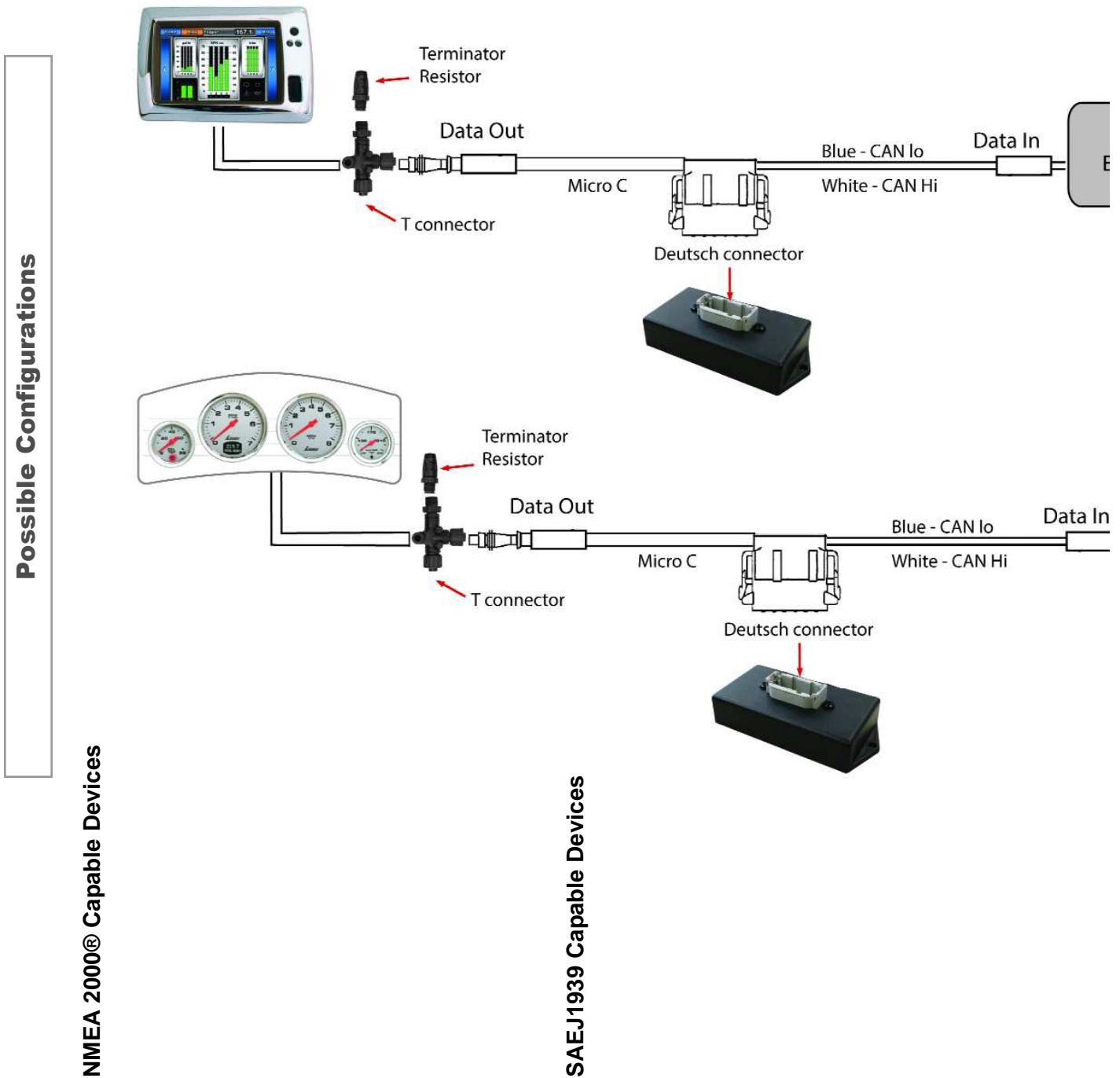

NMEA backbone cables, T fittings and power cable may be required if you are not tying into an existing backbone.

Please note that a terminating resistor is required for the system to perform as designed. Please see the next page for harness parts.



Harnessing/Accessories

Automotive/Marine

		
single T connector Part Number: 010-11078-00	120 Ohm female terminator Part Number: 010-11081-00	120 Ohm male terminator Part Number:010-11080-00
		
backbone/drop cable 2 ft Part Number: 000-10068-001	single power cable Part Number: 010-11079-00	
		
backbone/drop cable 6 ft Part Number: 010-11076-00	backbone/drop cable 18 ft Part Number: 010-11076-01	backbone/drop cable 30 ft Part Number: 010-11076-02